

TYPICAL ELEVATION

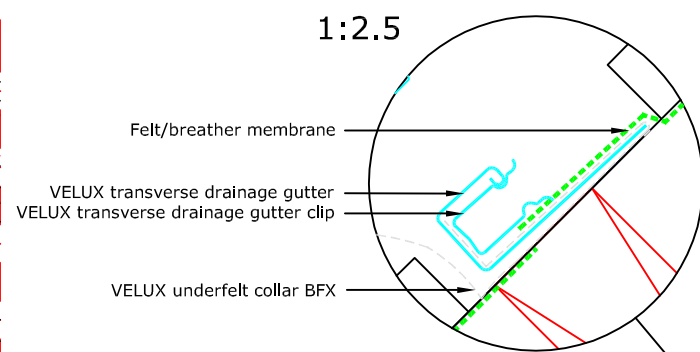

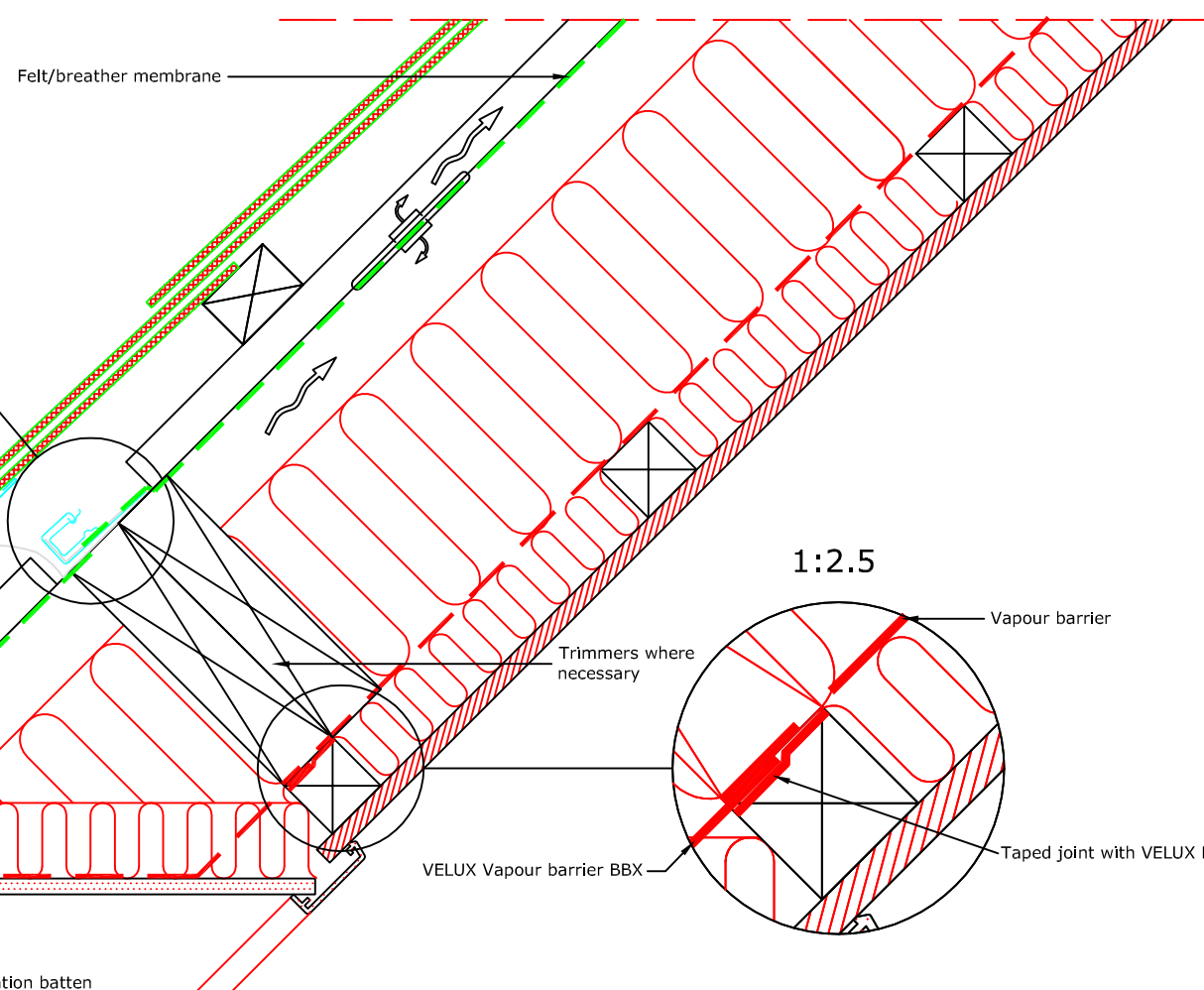





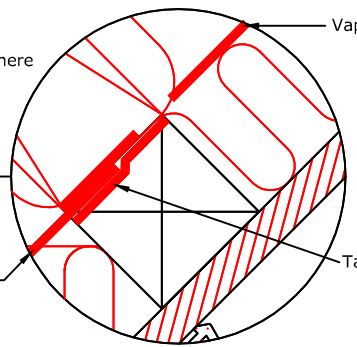

Section A-A  
1:5

1:2.5



1:2.5

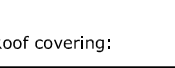

- VELUX Products:
-  GPL  
15°-55°  
\* 55°-75° with special springs
  -  EDL  
15°-90°
  -  BFX
  -  BDX
  -  BBX
  -  LS-
- Roof covering:
-  SLATES  
< 8 mm

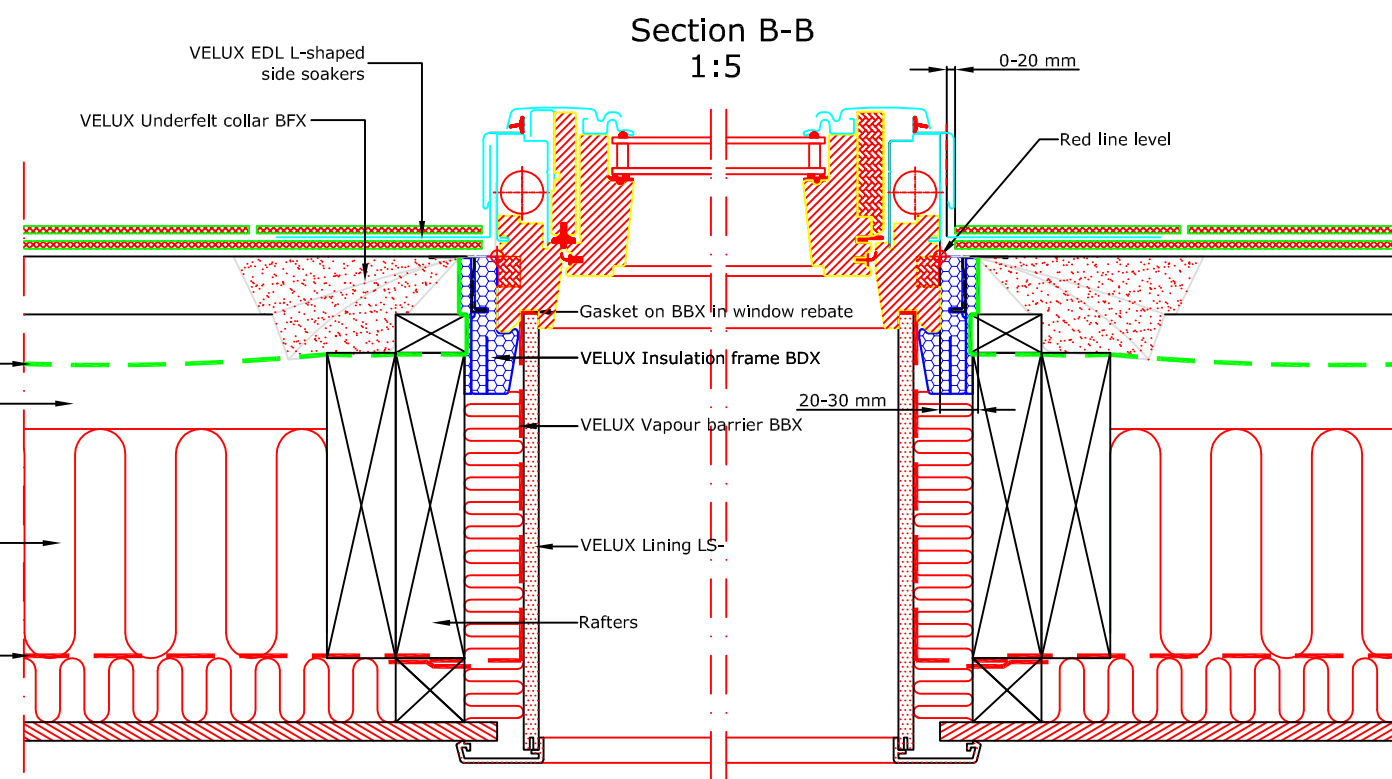
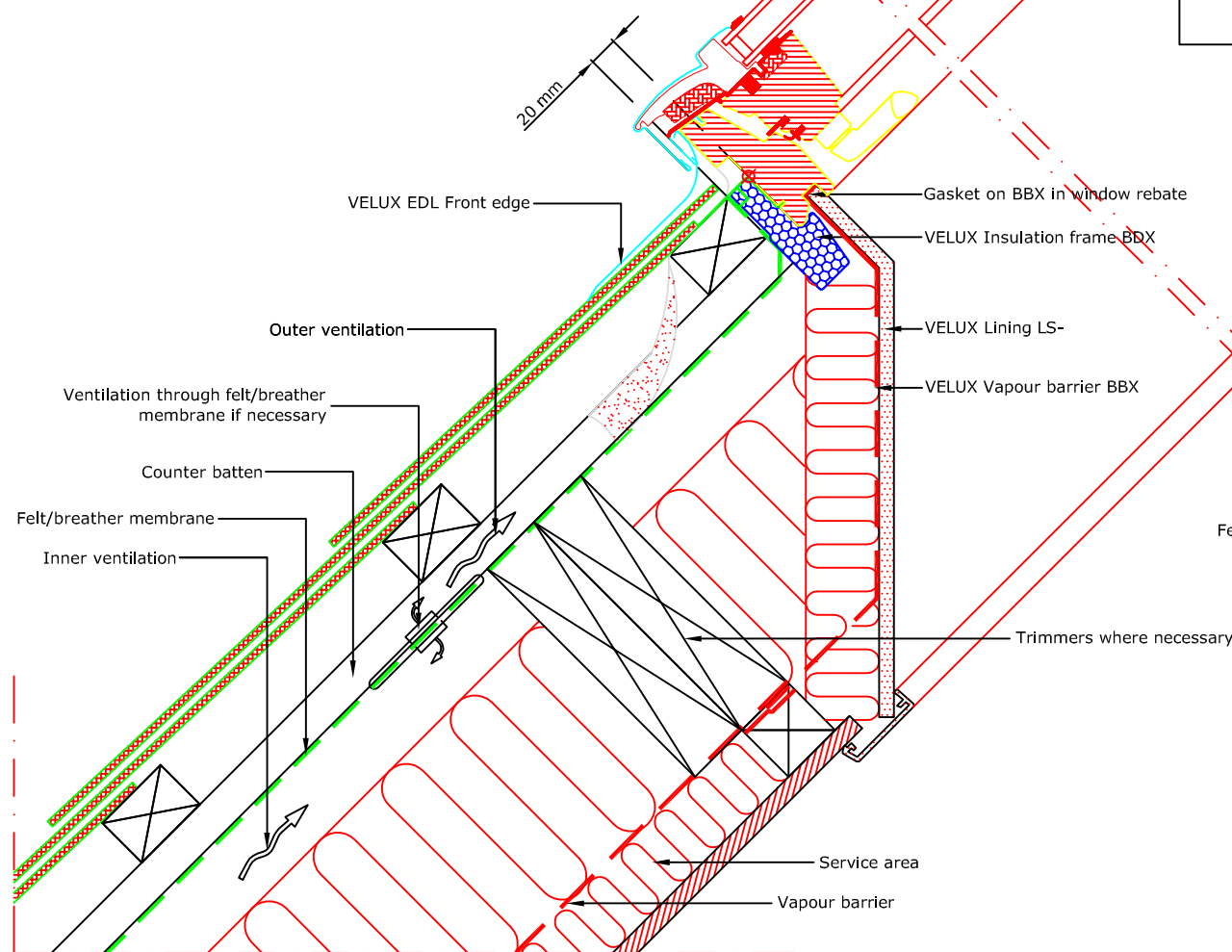

Section B-B  
1:5



VELUX Company Ltd  
Woodside Way  
Glenrothes, Fife KY7 4ND  
tel: +44 (0) 1592 778 225

VELUX top-hung roof window  
**GPL single installation into natural slate**  
EDL flashing kit - standard install into natural slate up to 8mm thick  
*All dimensions are in millimetres where shown*

NOTE! When installing VELUX roof windows, flashings and accessories, please ensure compliance with building regulations and British/European standards where necessary. This detail represents the principles of a typical installation only and the design and specification of the final detail is the responsibility of others.

Latest revision:

Date: **January 2014**  
Rev no:  
Rev date:  
Drawn: **PJH**

File name:  
**GPL-EDL-0114-1014**  
Scale: **1:5 approx. @ A3**